

INSTRUCTIONS FOR USE AND WARRANTY

TEMPUR® Beds excluding TEMPUR Arc™ and

TEMPUR ERGO® Smart Base beds

November 2025

Contents

INSTRUCTIONS FOR USE	3
Welcome to TEMPUR®	3
GENERAL SAFETY INSTRUCTIONS - APPLICABLE FOR ALL BED TYPES (excl. TEMPUR Arc™ and TEMPUR ERGO® Smart Base beds)	3
Symbols	4
Transport, moving, storage and disposal	5
That 'new product' smell	5
Please note additional instructions for use	5
Fire safety	6
Assembly	6
Cleaning and maintenance	6
ADDITIONAL INSTRUCTIONS FOR USING ADJUSTABLE TYPE BEDS	7
Troubleshooting	8
Additional information on the remote control	8
Emergency lowering	9
Additional information - cleaning and maintenance of electrical components	11
Disposal of electrical components	11
Dismantling the motor unit	12
DECLARATION OF CONFORMITY	13
WARRANTY	15
LIST OF BEDS COVERED BY INSTRUCTIONS FOR USE AND WARRANTY	19
BATTERY SUPPLIER INFORMATION	20

In case of any discrepancy between the meanings of any translated versions of this text, the meaning of the English language version shall prevail.

INSTRUCTIONS FOR USE

Welcome to TEMPUR®

Thank you and congratulations on choosing TEMPUR®.

This guide includes everything you need to know about caring for and getting the most out of your bed.

GENERAL SAFETY INSTRUCTIONS - APPLICABLE FOR ALL BED TYPES (excl. TEMPUR Arc™ and TEMPUR ERGO® Smart Base beds).

These general safety instructions apply to all bed types, except for TEMPUR Arc™ and TEMPUR ERGO® Smart Base beds.

A full list of the beds covered by these Instructions for Use is provided at the end of document, at page 19.

In the following chapters, the references below will be used to draw your attention to possible dangerous situations. Please be aware that failure to comply with these instructions may result in critical injuries or damage to the product.



DANGER

Be aware of an immediate dangerous situation, which can cause death or critical injuries, if not avoided.



WARNING

Be aware of a dangerous situation, which can cause death or critical injuries, if not avoided.



CAUTION

Be aware of a dangerous situation, which can cause minor or moderate injuries, if not avoided.

IMPORTANT











Be aware of a dangerous situation, which can cause damage to the product and/or other property, if not avoided.







NOTICE

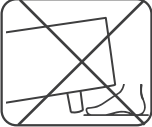
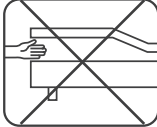





Directs attention to practical instructions and advice.

Symbols

The following symbols are used on the product, packaging, assembly instructions or in this manual.

	WEEE Label - appears on electrical and electronic equipment in the EU. It indicates that the product should be sent to separate collection facilities for recovery and recycling.		CE marked electrical equipment in accordance with EU regulations		Manufacturer
	Open the packaging carefully, so as not to damage the product and its parts. Dispose of the packaging safely and as sustainably as possible in your local area.		2-person assembly required		Avoid open flames
	Consult instructions for use		Head end		Foot end
	Prevent children playing with the bed		Keep feet at a safe distance		Trapping hazard - do not insert hands/fingers

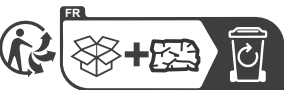
	Use 2 people to carry		This side up		The PAP logo gives the recycling code indicating what the packaging is made of
	Keep dry		Do not cut deeply into the packaging. Handle with care.		Humidity level

	Triman packaging sorting information, only relevant to France		
			

Transport, moving, storage and disposal



CAUTION

- At least 2 people should move the bed and its parts, as they may be heavy.
- Store the product in a dry environment (max. 65% relative humidity).
- Always follow the safety instructions in the assembly guides and on the labels attached to the product.

IMPORTANT

Packaging should be sorted into recyclable components and then disposed of in accordance with the appropriate national environmental regulations. Check with your local authority or retailer for recycling advice.

That 'new product' smell

Some people notice a slight odour to their new product once unpacked. This is completely harmless and will disappear after a short period of use.

Please note additional instructions for use

Please read the following information clearly as this will provide guidance on how to use your product and what to expect in the first few months.



WARNING

- For domestic use only.
- Immediately dispose of all packaging materials as they may pose a risk of suffocation.
- Do not use accessories/attachments that are not recommended by the manufacturer.

IMPORTANT

- The product should not be used in a moist environment.
- Avoid the use of this product outdoors.
- The product should not be used in any environment that will be cleaned with an automated washing system.
- For safe and longer use of the product, the maximum permitted weight on the bed surface is 150 kg (moving weight) per single bed base. Weight limit applies whether you're sleeping, sitting, or sitting on the edge.

Please note that the manufacturer cannot be held responsible if this maximum weight is exceeded.

Fire safety

Bed products comply with applicable safety standards, which may vary depending on the product or the region. Further information is available upon request.

Carelessness causes fire - we strongly recommend that you do not smoke in bed.



WARNING

- Risk of fire: keep products away from open flames.

Assembly

For correct and safe assembly, PLEASE SEE THE ASSEMBLY GUIDES FOR FULL INSTRUCTIONS.

Cleaning and maintenance

A clean bedroom can have a big impact on your sleeping environment and therefore sleep quality.

To ensure the preservation of your bed's appearance, we recommend regular vacuuming with a soft fitting, preferably once a week. This gently removes the dust from the surface without damaging the textile and reduces dust collection.

IMPORTANT

- Always remove stains as quickly as possible before it penetrates the fibres. This may result in a permanent stain.
- Avoid soaking as this can seep through the fabric and damage the underlying material.
- DO NOT rub the material too vigorously to remove a stain as this may damage the material.

NOTICE

- For liquid spills, absorb as much of the liquid as possible with a plain white kitchen paper towel or cotton cloth to avoid a permanent stain.
- Most spots can be removed with lukewarm water, using a pH-neutral dishwashing detergent if necessary.
- If a stain or spot has dried, remove as much as possible by vacuuming with a soft brush fitting.

ADDITIONAL INSTRUCTIONS FOR USING ADJUSTABLE BEDS

Please read the following information clearly as this will provide guidance on how to use your product and what to expect in the first few months.



WARNING

- Only use the adjustable bed for its intended use, as described in this manual.
- Adjustable beds can only be used by the users listed below when supervised or when they have been instructed on safe use and fully understand the risks involved.

These users include:

- Children of 8 years and older
 - Persons with reduced physical, sensory or mental capabilities
 - Persons with lack of experience or knowledge
- Children should be supervised to ensure that they do not play with the bed.
 - Cleaning and user maintenance must NOT be carried out by children without supervision.
 - Do not allow children and/or pets to play on or under the bed.
 - Do not use accessories/attachments that are not recommended by the manufacturer.



DANGER

- Do not use in any environment where combustible, explosive gases or vapours may be present (e.g. anaesthesiology).



WARNING

- Batteries included with the electronic accessories are not rechargeable and are not to be placed in a battery charger.
- Place the remote control units in a safe location when not in use.



CAUTION

- Do not sit or stand on the end of the frames while they are in upright positions.
- When adjusting the position of the bed base, take extra care not to get your fingers caught in the mechanism.

IMPORTANT

- Lower the bed to a flat position when not in use.
- Do not use for raising or lowering loads in industrial or technical settings.
- Avoid forces which exceed the specified ratings on the motor unit's ratings plate.
- To prevent distortion of the bed fittings, the bed must be placed on an even surface.



CAUTION

- Electrical components should be connected or disconnected only when the power supply cord is unplugged.

Troubleshooting

This chapter describes troubleshooting methods for fixing problems during assembly and daily use.

What to do in case of error:

If you experience an error that is not listed in the table below, please contact your retailer.

Problems	Possible cause	Solution
The remote control or motor system is not functioning. The drive suddenly does not move.	There may be no mains power supply.	Check and reconnect to the mains power supply.
	A lead-in connection has been interrupted.	Check the cables and reinsert them, if required.
	The remote control battery is dead.	Check the battery and replace if necessary.
	The remote control or motor is defective.	Please contact your retailer.

PLEASE CHECK THE ADJUSTABLE FRAMES ASSEMBLY GUIDES FOR PAIRING AND RESETTING OF REMOTE CONTROLS AND MOTORS

Additional info on the remote control's batteries

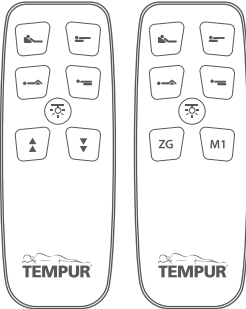
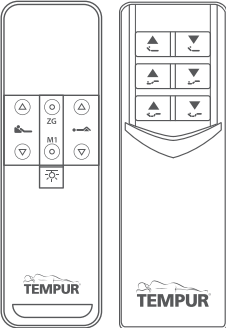
	
1 pc flat button cell CR2023 3V battery	2 pcs AAA 1.5 V batteries

Emergency lowering

Emergency lowering is intended for lowering the bed if a power failure occurs and the bed needs to be moved into the flat position.

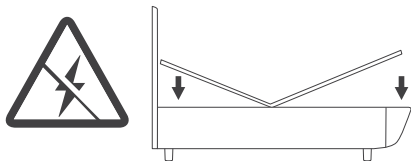

There are different types of motors in TEMPUR® beds. Please check carefully what type of motor your bed has before continuing.

Type 1

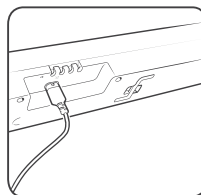
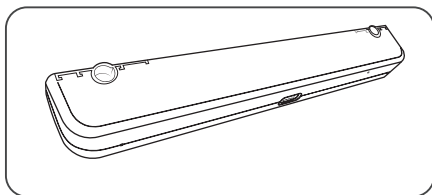

Type 2

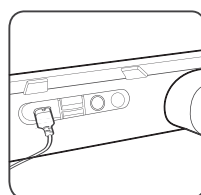
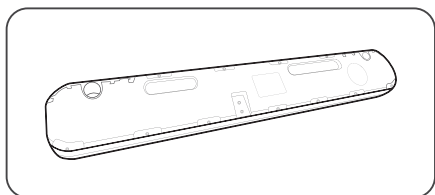

If your bed has Type 1 motor, please follow these steps to manually lower your bed.

1. Disconnect the motor from the mains.
2. Take the hex key from the side of the motor (you can use a pen or similar to push the key out).

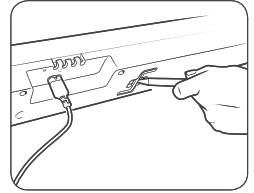

Do not use an electric screwdriver for lowering. Always use the hex key.

3. Underneath the motor, at the foot and head end side, are two gaps for mechanical lowering.
4. Place the hex key in the gap, one end at a time.
5. At the head end side, turn the hex key in an anticlockwise direction and for the foot end side turn it clockwise.

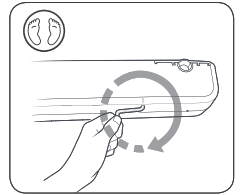
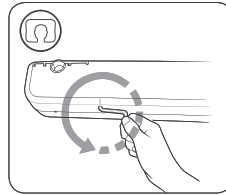

It is important to turn the hex key in the right direction. Turning the key in the wrong direction can damage the inner hex and make mechanical emergency lowering impossible.

If your bed has Type 2 motor, please follow these steps to lower your bed.

1. Disconnect the motor from the mains.
2. There is a 9V battery attached to the motor. Fully connect it if this has not been done before.

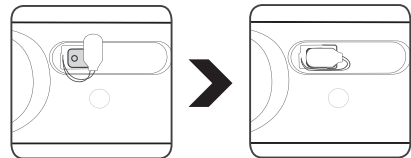

3. Press and hold the button on the motor until the surface of bed base is completely flat.

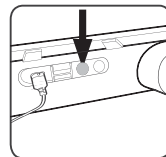

4. Replace the 9V battery with a fresh one after every use.

Additional info about cleaning and maintenance of electrical components

NOTICE

- Always disconnect the power supply before you start to clean the drive system!
- Never clean the motor unit in an automated washing system or with a high pressure cleaner.
- Do not allow fluids to penetrate the unit. It could result in damage to the system.
- Do not use a cleanser that contains benzene, alcohol or similar solvents.
- Clean the electrical components as needed using a dry anti-static cloth.
- Make sure that you do not damage the drive's connecting cable.

Disposal of electrical components

To protect the environment and for the best possible reuse, please follow the recycling advice below:

Electrical and electronic components

To help protect the environment, waste electrical products should not be disposed of with household waste. Please recycle where possible. Check with your local authority or retailer for recycling advice and for your nearest electrical waste disposal facility.

Electrical and electronic equipment contains materials, components, and substances that may be hazardous and present a risk to human health and the environment when not handled correctly.

Equipment marked with the crossed-out wheeled bin symbol is electrical and electronic equipment. The crossed-out wheeled bin symbol indicates that the equipment must not be discarded with unsorted household waste, but must be disposed of separately.

Consumers should use the collection schemes available to reduce adverse environmental impacts in connection with disposal of waste electrical and electronic equipment and to increase opportunities for reuse, recycling, and recovery of waste electrical and electronic equipment.



Dismantling the motor unit



CAUTION

- Electrical components should be connected or disconnected only when the power supply cord is unplugged.
- Danger of pinching/crushing injuries!
Please ensure that any work on the drive system is only done where there are no weight-bearing loads on it, to avoid any risk of crushing or other injury.



The disposal of the batteries is regulated in the EU by the Battery Regulation (Regulation (EU) 2023/1542), and internationally by the equivalent applicable national laws and regulations.

The battery should not be disposed of with normal household waste. Check with your local authority or retailer for recycling advice.

1. Ensure the bed is not bearing a load.
2. Disconnect the motor from the power supply!
3. Disconnect all the connecting cables.
4. Turn the bed base onto its side and then upside down.
5. Pull the catches (A) sideways until they are completely free.
6. Pull the motor out far enough so that the brackets (C) come out of the slots (B).
7. The motor is now unattached and can be removed.
8. Push the catches (A) back into the motor so that they are not lost during transportation.

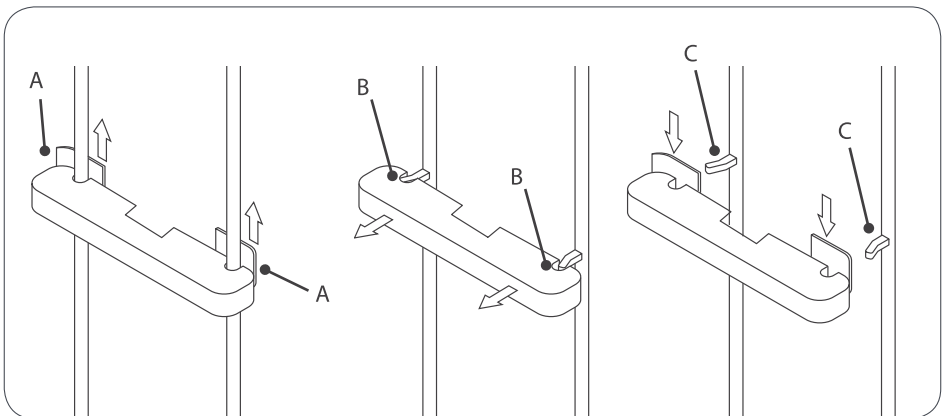

DECLARATION OF CONFORMITY

The manufacturer, Osäuhing Bed Factory Sweden, a subsidiary of Tempur Sealy International, Inc. registered in Riia 66, EE-71009 Viljandi, Estonia, declare that the following products, **TEMPUR Cloud®**, **TEMPUR Dual®**, **TEMPUR Experience™**, **TEMPUR Move™**, **TEMPUR North™**, **TEMPUR ONE™**, **TEMPUR® Promise** adjustable bed bases as delivered, are in conformity with the requirements of the following EU directives and standards:

Directives	Subject
Directive 2006/42/EC	Machinery
Directive 2011/65/EU	RoHS
Directive 2014/35/EU	LVD (Low Voltage Directive)
Directive 2014/53/EU	RED (Radio Equipment Directive)
Directive 2014/30/EU	EMC (Electromagnetic Compatibility)
Directive 2009/125/EC	Ecodesign

Standards	Subject
Standard ISO 19833:2018	Furniture — Beds — Test methods for the determination of stability, strength, and durability
Standard EN 13759:2012	Furniture. Operating mechanisms for seating and sofa-beds. Test methods

Partial conformity	Subject
Standard EN1725:1998	Domestic furniture. Beds and mattresses. Safety requirements and test methods

This declaration of conformity is issued under the sole responsibility of the manufacturer.

Signed on 25.06.24 for and on behalf of:

Osäuhing Bed Factory Sweden,
 A subsidiary of Tempur Sealy International, Inc.
 Riia 66, EE-71009 Viljandi, Estonia



Indrek Aasna - Managing Director



Renel Pakkas - Controller

DECLARATION OF CONFORMITY

The manufacturer, Osäuhing Bed Factory Sweden, a subsidiary of Tempur Sealy International, Inc. registered in Riia 66, EE-71009 Viljandi, Estonia, declare that the following products, **TEMPUR FORM™**, **TEMPUR® Relaxation** adjustable bed bases as delivered, are in conformity with the requirements of the following EU directives and standards:

Directives	Subject
Directive 2006/42/EC	Machinery
Directive 2011/65/EU	RoHS
Directive 2014/35/EU	LVD (Low Voltage Directive)
Directive 2014/53/EU	RED (Radio Equipment Directive)
Directive 2014/30/EU	EMC (Electromagnetic Compatibility)
Directive 2009/125/EC	Ecodesign

Standards	Subject
Standard ISO 19833:2018	Furniture — Beds — Test methods for the determination of stability, strength, and durability
Standard EN 13759:2012	Furniture. Operating mechanisms for seating and sofa-beds. Test methods

Partial conformity	Subject
Standard EN1725:2023	Domestic furniture. Beds and mattresses. Safety requirements and test methods

This declaration of conformity is issued under the sole responsibility of the manufacturer.

Signed on 25.06.24 for and on behalf of:

Osäuhing Bed Factory Sweden,
 A subsidiary of Tempur Sealy International, Inc.
 Riia 66, EE-71009 Viljandi, Estonia



Indrek Aasna - Managing Director



Renel Pakkas - Controller

WARRANTY

TEMPUR® WARRANTY

This document sets out the terms and exclusions of the TEMPUR® Warranty for new TEMPUR® beds (excl. TEMPUR Arc™ and TEMPUR ERGO® Smart Base beds) sold to consumers worldwide (excluding the USA and Canada).

The list of beds covered by this Warranty is provided at the end of document, at page 19.

Who offers the TEMPUR® Warranty?

The Manufacturer of the beds is Bed Factory Sweden OÜ, a company registered in Estonia under company registration number 11133916. Registered office address: Riia mnt 66 Viljandi 71009, Estonia. Bed Factory Sweden OÜ (the Manufacturer) is a subsidiary of Tempur-Sealy International, Inc.

What is covered?

The Manufacturer warrants that all new and genuine beds are free from material defects due to faulty workmanship or materials for the applicable warranty period (see section - For how long?) unless the product is specifically excluded, or an exclusion applies (see section - Exclusions).

The TEMPUR® Warranty is valid for products purchased by consumers anywhere in the world (except the USA and Canada) from the Manufacturer or an authorised retailer for personal use and not in the course of a business, trade, or profession. A list of authorised retailers is available at www.tempur.com

For how long?

The TEMPUR® Warranty lasts for the period as stated in the table below, starting from the date of purchase (except where the product is an ex-display or demonstration model in which case the warranty starts from the date of manufacture).

The warranty period is generally as set out in the warranty table, but the Manufacturer advises that you should check the warranty terms for the country in which you originally purchased your product as there may be a different warranty period applicable. For this, please visit warranty.tempur.com

Product: Beds and bed parts	Product Warranty	What's covered?
Bed bases, bed frames and headboards	5 years	Material defects due to faulty workmanship or materials.
Adjustable beds electrical components: motor, remote control, and LED lights	2 years	Material defects due to faulty workmanship or materials.

What will we do?

Where a valid claim is made in accordance with the TEMPUR® Warranty, the Manufacturer shall offer, at its own discretion, to either repair the defective product or provide an equivalent replacement product free of charge.

The Manufacturer will refund the reasonable delivery cost of returning a defective product for repair or replacement so long as the claim is valid under the terms of this TEMPUR® Warranty and the product is returned from an address in the same country as the authorised retailer the product was purchased from. The repaired or replacement product will be delivered free of charge to an address in the same country as the authorised retailer the product was purchased from. In all other circumstances, any delivery costs associated with any repairs or replacements are the purchaser's responsibility.

In the event of replacement, the Manufacturer shall endeavor to provide a replacement product from the same line. However, if the product line has been discontinued or the product is otherwise not available, the Manufacturer reserves the right to provide a replacement product that, in the Manufacturer's sole discretion, is similar to the defective product.

The Warranty provides cover from the date of purchase (or date of manufacture in the case of ex-display/demonstration products) of the original product. It is not renewed on the provision of a repaired or replaced product. In these circumstances, the Warranty will run for the remainder of the period starting from the original purchase or manufacture date, as applicable.

Exclusions

The TEMPUR® Warranty does not apply if:

- the product has been purchased used, second hand or from anyone other than an authorised retailer or directly from the Manufacturer. A list of authorised retailers is available at www.tempur.com
- the process for making a claim under the TEMPUR® Warranty (set out under the heading “How do you claim under the TEMPUR® Warranty?” below) has not been correctly followed.
- the product has not been used and/or handled with due care and/or in accordance with the instructions of use, cleanliness and maintenance described in the Instructions for Use and at warranty.tempur.com
- the product has been deliberately damaged or damaged as a result of neglect, cuts, burns, flooding or any other improper use by you or by any third party.
- the product has been wet or soaked against the Manufacturer’s recommendations.
- the product is found to be overtly stained, soiled and/or otherwise unhygienic.
- the product has been altered or repaired without the Manufacturer’s prior permission.
- the defect is the result of normal wear and tear.
- the motors or remote have/has been opened or tampered with; with the exception of battery compartments, the warranty will be void if the internal workings of these components are tampered with.
- Has been overloaded or misused against the manufacturer’s weight restrictions.

How do you claim under the TEMPUR® Warranty?

To claim under the Warranty you must:

- contact the authorised retailer you originally purchased the product from (the “Seller”). If the Seller is either no longer in business or is no longer a authorised retailer, please contact the Manufacturer.
- present the original invoice or sales receipt as evidence of the purchase.
- return the product to the Seller or to the Manufacturer (but only if the Manufacturer has requested the product). If the Manufacturer determines that the claim is valid in accordance with the terms of this Warranty, you will be refunded the reasonable delivery costs for returning the defective product, so long as the product has been returned from an address within the same country as the Seller.

Our liability to you

The liability of the Manufacturer is limited to the cost of repair and/or replacement of the products under the bed Warranty. Accordingly, the Manufacturer will not be liable for all other liability for loss or damage howsoever caused arising out of the purchase, possession, sale, or use of the product. However, the Manufacturer does not exclude or limit in any way its liability for death or personal injury caused by its negligence, or fraud or fraudulent misrepresentation.

The products are only sold for domestic and private use. The Manufacturer has no liability to you for any loss of profit, loss of business, business interruption or loss of business opportunity.

Your legal rights

The Warranty does not affect a consumer's statutory rights under applicable law but aims to enhance the consumer's rights where applicable.

LIST OF BEDS COVERED BY INSTRUCTIONS FOR USE AND WARRANTY:

TEMPUR Cloud®
TEMPUR Dual®
TEMPUR Ease™
TEMPUR Exhale™
TEMPUR FORM™
TEMPUR Move™
TEMPUR ONE™
TEMPUR Relieve®
TEMPUR Stay™
TEMPUR Experience™
TEMPUR North™
TEMPUR® Promise
TEMPUR® Relaxation
TEMPUR® Sensation

BATTERY SUPPLIER INFORMATION

Please check your battery to see which manufacturer details apply.

Manufacturer:

GP Batteries International Limited

7/F Building 16W, 16 Science Park West Avenue, Hong Kong Science Park

international.gpbatteries.com

info@gpbatteries.com

Importer: LINAK A/S

Smedevænget 8, Guderup DK-6430 Nordborg, Denmark

www.linak.com

lks@linak.com

Manufacturer:

Shenzhen DeAnda Technology Co., Ltd.

3rd Floor, Building A3, Hongjingwei Science and Technology Park,

No. 47 Dongxin Avenue, Dongjiang High tech Zone, Huizhou City, China

www.qsg-energy.cn

Manufacturer:

Fujian Nanping Nanfu Battery Co., Ltd.

109 Industry Road, Yanping District, Nanping, Fujian, P.R.China P.C. 353000

www.nanfu.com

nanfuglobal@nanfu.com

Importer: DewertOkin Kft

Szent István krt. 24, 6000 Kecskemét, Hungary

www.dewertokin.hu

info@dewertokin.hu

Manufacturer:

VARTA Consumer Batteries GmbH & Co. KGaA

Alfred-Krupp-Straße 9, 73479 Ellwangen, Germany

www.varta-ag.com/en